



Robert Bosch Power Tools GmbH

70538 Stuttgart
GERMANY

www.bosch-pt.com

1 609 92A 3F7 (2016.10) 0 / 214



1 609 92A 3F7

GLM 500 Professional



BOSCH

- en Original instructions
- cn 正本使用说明书
- tw 原始使用說明書
- ko 사용 설명서 원본
- th หนังสือคู่มือการใช้งานฉบับต้นแบบ
- id Petunjuk-Petunjuk untuk
Penggunaan Orisinal
- vi Bản gốc hướng dẫn sử dụng





2 |



English.....	Page	12
中文	页	46
中文	頁	72
한국어	페이지	99
ภาษาไทย.....	หน้า	126
Bahasa Indonesia	Halaman	154
Tiếng Việt	Trang	183

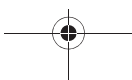

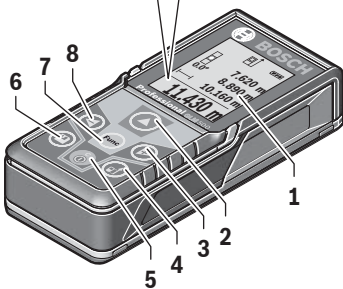
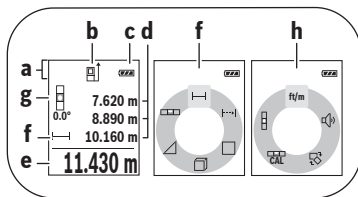

GLM 500

4 |

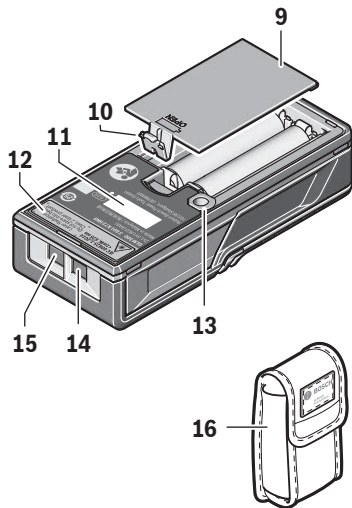

GLM 500

1 609 92A 3F7 | (13.10.16)

Bosch Power Tools

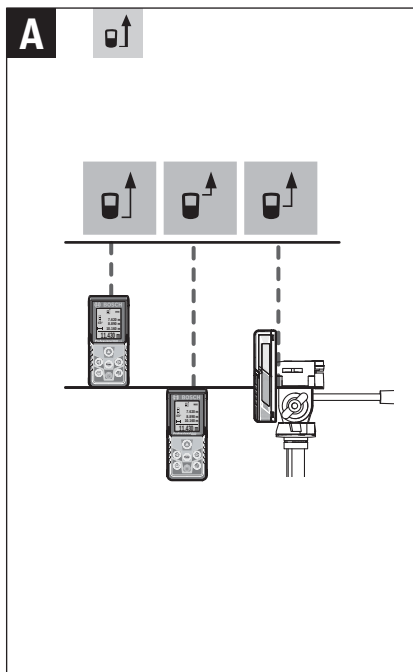

6 |

B

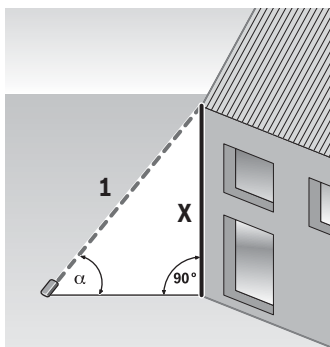

1 609 92A 3F7 | (13.10.16)

Bosch Power Tools

C

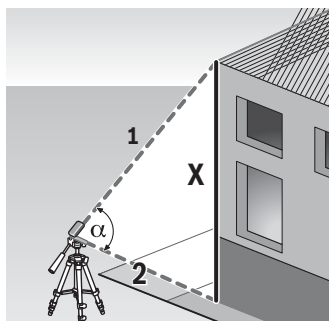

8 |

D

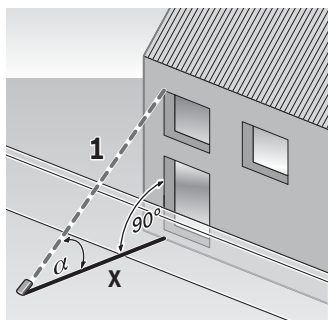

1 609 92A 3F7 | (13.10.16)

Bosch Power Tools

E1

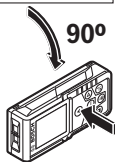
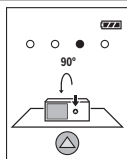
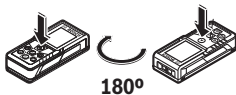
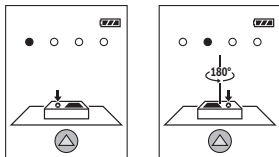

10 |

E2

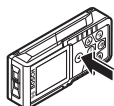
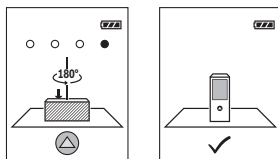

180°

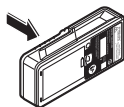

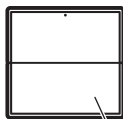

17
2 607 001 391



18
1 608 M00 05B



19
BT 150
0 601 096 B00

12 | English

English

Safety Notes



All instructions must be read and observed in order to work safely with the measuring tool. The integrated protections in the measuring tool may be compromised if the measuring tool is not used in accordance with the instructions provided. Never make warning signs on the measuring tool unrecognisable. **STORE THESE INSTRUCTIONS IN A SAFE PLACE AND INCLUDE THEM WITH THE MEASURING TOOL WHEN GIVING IT TO A THIRD PARTY.**

- ▶ **Caution** – The use of other operating or adjusting equipment or the application of other processing methods than those mentioned here can lead to dangerous radiation exposure.
- ▶ **The measuring tool is provided with a warning label (marked with number 12 in the representation of the measuring tool on the graphics page).**



- ▶ **If the text of the warning label is not in your national language, stick the provided warning label in your national language over it before operating for the first time.**



Do not direct the laser beam at persons or animals and do not stare into the direct or reflected laser beam yourself, not even from a distance. You could blind somebody, cause accidents or damage your eyes.

- ▶ **If laser radiation strikes your eye, you must deliberately close your eyes and immediately turn your head away from the beam.**
- ▶ **Do not make any modifications to the laser equipment.**
- ▶ **Do not use the laser viewing glasses as safety goggles.** The laser viewing glasses are used for improved visualisation of the laser beam, but they do not protect against laser radiation.
- ▶ **Do not use the laser viewing glasses as sun glasses or in traffic.** The laser viewing glasses do not afford complete UV protection and reduce colour perception.

14 | English

- ▶ **Have the measuring tool repaired only through qualified specialists using original spare parts.** This ensures that the safety of the measuring tool is maintained.
- ▶ **Do not allow children to use the laser measuring tool without supervision.** They could unintentionally blind other persons or themselves.
- ▶ **Do not operate the measuring tool in explosive environments, such as in the presence of flammable liquids, gases or dusts.** Sparks can be created in the measuring tool which may ignite the dust or fumes.

Product Description and Specifications

Intended Use

The measuring tool is intended for measuring distances, lengths, heights, clearances and inclines, and for calculating areas and volumes.

Technical Data

Digital Laser Measure	GLM 500		
Article number	... H50	... HK0	... HC0
3 601 K72 ...			

1 609 92A 3F7 | (13.10.16)

Bosch Power Tools

English | 15

Digital Laser Measure	GLM 500		
Setting the unit of measure	m, cm	m, cm, ft, in (fractions), ft/in (fractions)	m, cm, Taiwan ft
Measuring range (typical)	0.05 – 50 m ^{A)}		
Measuring range (typical under unfavourable conditions)	20 m ^{B)}		
Measuring accuracy (typical)	± 1.5 mm ^{A)}		
Measuring accuracy (typical under unfavourable conditions)	± 3.0 mm ^{B)}		
Lowest indication unit	0.1 mm		
Indirect Distance Measurement and Vial			
Measuring range	0° – 360° (4x90°)		
Inclination measurement			
Measuring range	0° – 360° (4x90°)		
Measuring accuracy (typical)	± 0.2° ^{C)/D)/G)}		

Bosch Power Tools

1 609 92A 3F7 | (13.10.16)

16 | English

Digital Laser Measure	GLM 500
Lowest indication unit	0.1°
General	
Operating temperature	-10 °C... +45 °C ^{E)}
Storage temperature	-20 °C... +70 °C
Relative air humidity, max.	90 %
Laser class	2
Laser type	635 nm, < 1 mW
Laser beam diameter (at 25 °C) approx. - at 10 m distance - at 50 m distance	9 mm ^{D)} 45 mm ^{D)}
Automatic switch-off after approx. - Laser - Measuring tool (without measurement)	20 s 5 min
Weight according to EPTA-Procedure 01:2014	0.10 kg
Dimensions	106 x 45 x 24 mm
Degree of protection	IP 54 (dust and splash proof) ^{F)}
Batteries	2 x 1.5 V LR03 (AAA)
Rechargeable batteries	2 x 1.2 V HR03 (AAA)

English | 17

Digital Laser Measure	GLM 500
Battery life, approximately	
– Individual measurements	10000
– Continuous measurement	2.5 h
Setting the sound	●

A) For measurements from the rear measuring tool edge, weak backlighting and 25 °C operating temperature are applicable for high reflectivity of the target (e.g. a white-painted wall). In addition, a deviation influence of ± 0.05 mm/m must be taken into account.

B) For measurements from the rear measuring tool edge, applies to high reflectivity of the target (e.g. white cardboard), strong backlighting and – 10 °C to + 45 °C operating temperature. In addition, a deviation influence of ± 0.15 mm/m must be taken into account.

C) After calibration at 0 ° and 90 ° with an additional grade error of ± 0.01 °/degree to 45 ° (max.).

D) At 25 °C operating temperature

E) In the continuous measurement function, the maximum operating temperature is + 40 °C.

F) except battery compartment

G) The left-hand side of the measuring tool serves as the reference level for grade measurement.



The measuring tool can be clearly identified with the serial number **11** on the type plate.

Bosch Power Tools

1 609 92A 3F7 | (13.10.16)

18 | English**Product Features**

The numbering of the product features shown refers to the illustration of the measuring tool on the graphic page.

- 1 Display
- 2 Measuring button [▲]
- 3 Plus button [+]
- 4 Button for selection of the reference level
- 5 On/Off button []
- 6 Memory button []
- 7 Function button [**Func**]
- 8 Minus button [-]
- 9 Battery lid
- 10 Latch of battery lid
- 11 Serial number
- 12 Laser warning label
- 13 1/4"- Tripod socket
- 14 Reception lens
- 15 Laser beam outlet
- 16 Protective pouch*
- 17 Laser target plate*
- 18 Laser viewing glasses*
- 19 Tripod*

***The accessories illustrated or described are not included as standard delivery.**

Display elements (selection)

- a Status bar
- b Measurement reference level
- c Battery indicator
- d Measured-value lines
- e Result line
- f Measuring functions
- g Display tilt angle
- h Basic configurations

Assembly

Inserting/Replacing the Batteries

Using alkali-manganese or rechargeable batteries is recommended for operation of the measuring tool.

With 1.2-V-rechargeable batteries fewer measurements could be possible than with 1.5-V-batteries.

To open the battery lid **9**, press the latch **10** and remove the battery lid. Insert the batteries/rechargeable batteries. When inserting, pay attention to the correct polarity according to the representation on the inside of the battery compartment.

When the empty battery symbol appears on the display, then approx. 100 measurements are still possible. When the battery symbol is empty and flashes

20 | English

red, no further measurements are possible. Change the batteries or rechargeable batteries.

Always replace all batteries/rechargeable batteries at the same time. Do not use different brands or types of batteries/rechargeable batteries together.

- ▶ **Remove the batteries/rechargeable batteries from the measuring tool when not using it for longer periods.** When storing for longer periods, the batteries/rechargeable batteries can corrode and self-discharge.

Operation

Initial Operation

- ▶ **Do not leave the switched-on measuring tool unattended and switch the measuring tool off after use.** Other persons could be blinded by the laser beam.
- ▶ **Protect the measuring tool against moisture and direct sun light.**
- ▶ **Do not subject the measuring tool to extreme temperatures or variations in temperature.** As an example, do not leave it in vehicles for a long time. In case of large variations in temperature, allow the measuring tool to adjust to the ambient temperature before putting it into operation.

English | 21

In case of extreme temperatures or variations in temperature, the accuracy of the measuring tool can be impaired.

- ▶ **Avoid heavy impact to or falling down of the measuring tool.** After severe exterior effects to the measuring tool, it is recommended to carry out an accuracy check (see “Accuracy Check of the Distance Measurement”, page 36) each time before continuing to work.

Switching On and Off

- To **switch on** the measuring tool and the laser, briefly press the measuring button **2** [▲].
- To **switch on** the measuring tool without the laser, briefly press the On/Off button **5** [⊙].
- ▶ **Do not point the laser beam at persons or animals and do not look into the laser beam yourself, not even from a large distance.**

To **switch off** the measuring tool, press and hold the On/Off button **5** [⊙].

The measured values and device settings in the memory are retained when you switch the tool off.

Measuring Procedure

Once switched on, the measuring tool is in the length measurement function. For a different measuring function, press the button **7** [Func]. Select the de-

22 | English

sired measuring function with the buttons **3** [**+**] or the button **8** [**-**] (see “Measuring Functions”, page 24). Activate the measuring function with button **7** [**Func**] or with the measuring button **2** [**▲**].

After switching on, the rear edge of the measuring tool is preset as the reference level for the measurement. To change the reference level, see “Selecting the Reference Level”, page 23.

Place the measuring tool against the desired starting point of the measurement (e. g. a wall).

Note: If the measuring tool has been switched on using the On/Off button **5** [**⊙**], briefly press the measuring button **2** [**▲**] to switch the laser on.

To initiate the measurement, briefly press the measuring button **2** [**▲**]. Then the laser beam is switched off. For a further measurement, repeat this process.

► **Do not point the laser beam at persons or animals and do not look into the laser beam yourself, not even from a large distance.**

Note: The measured value typically appears within 0.5 s and no later than approx. 4 s. The duration of the measurement depends on the distance, the lighting conditions and the reflective properties of the target surface. Upon completion of the measurement the laser beam is automatically switched off.

Selecting the Reference Level (see figure A)

For the measurement, you can select between three different reference planes:

- the rear measuring-tool edge (e.g. when measuring onward from a wall),
- the front measuring-tool edge (e.g. when measuring onward from a table edge),
- the centre of thread **13** (e.g. for tripod measurements).

To select the reference level, press button **4**. Use button **3** [**+**] or button **8** [**-**] or button **4** to select the desired reference level. The rear edge of the measuring tool is pre-set as the reference level every time the measuring tool is switched on.

“Basic Settings”

To enter the “basic configurations” menu (**h**) press and hold the button **7** [**Func**].

Select the respective basic configuration and your setting.

To exit the “basic configurations” menu, press the On/Off button **5** [

24 | English

Display Illumination

The display illumination is continuously switched on. When no button is pressed, the display illumination is dimmed after approx. 20 seconds to preserve the batteries/rechargeable batteries.

Measuring Functions**Length Measurement**

Select the length measurement .

To switch on the laser beam, briefly press the measuring button **2** [▲].

To measure, briefly press the measuring button **2** [▲]. The measured value will be shown at the bottom of the display.

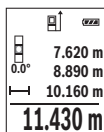

Repeat the above-mentioned steps for each subsequent measurement. The last measured value is at the bottom of the display, the penultimate measured value is above it, and so on.

Continuous Measurement (Tracking)

For continuous measurements, the measuring tool can be moved relative to the target, whereby the measuring value is updated approx. every 0.5 seconds. In this manner, as an example, you can

1 609 92A 3F7 | (13.10.16)

Bosch Power Tools



English | 25

move a certain distance away from a wall, while the actual distance can always be read.

Select the continuous measurement .

To switch on the laser beam, briefly press the measuring button **2** .

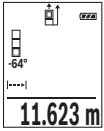
Move the measuring tool until the required distance value is indicated in the bottom of the display.

 Briefly pressing the measuring button **2**  interrupts the continuous measurement. The current measured value will be shown at the bottom of the display. Pressing the measuring button **2**  once more restarts the continuous measurement.

Continuous measurement automatically switches off after 5 mins.

Area Measurement

Select the area measurement .

Then measure the width and length one after the other as with a length measurement. The laser beam remains switched on between the two measurements. The distance to be measured flashes in the indicator for area measurement .

26 | English

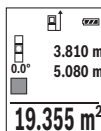

The first measured value is shown at the top of the display.

After the second measurement has been completed, the area will be automatically calculated and displayed. The end result is shown at the bottom of the display, while the individual measured values are shown above it.

Volume Measurement

Select the volume measurement .

Then measure the width, length and depth one after the other as with a length measurement. The laser beam remains switched on between the three measurements. The distance to be measured flashes in the indicator for volume measurement .

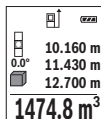

The first measured value is shown at the top of the display.

After the third measurement has been completed, the volume will be automatically calculated and displayed. The end result is shown at the bottom of the display, while the individual measured values are shown above it.

Indirect Distance Measurement

For indirect length measurements, three measuring modes are available. Each measuring mode can be used for determining different distances.

The indirect distance measurement is used to measure distances that cannot be measured directly because an obstacle would obstruct the laser beam or no target surface is available as a reflector. This measuring procedure can only be used in vertical direction. Any deviation in horizontal direction leads to measuring errors.

Note: Indirect distance measurement is always less accurate than direct distance measurement. Depending on application, greater measuring errors are possible than with direct distance measurement. To improve the measuring accuracy, we recommend using a tripod (accessory).

The laser beam remains switched on between the individual measurements.

a) Indirect height measurement (see figure B)

Select the indirect height measurement .

Ensure that the measuring tool is at the same height as the lower measuring point. Then tilt the measuring tool around the reference level and measure the distance “1” as for a length measurement (displayed as a red line).

28 | English

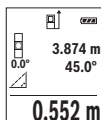

Upon completion of the measurement, the result for the sought distance “X” is displayed in the result line **e**. The measuring values for the distance “1” and the angle “ α ” are displayed in the measured-value lines **d**.

b) Double indirect height measurement (see figure C)

The measuring tool can indirectly measure all distances, which lie in the vertical level of the measuring tool. Select the double indirect height measurement .

Measure distances “1” and “2” in this sequence as for a length measurement.

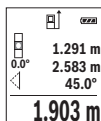

Upon completion of the measurement, the result for the sought distance “X” is displayed in the result line **e**. The measuring values for the distances “1”, “2” and the angle “ α ” are displayed in the measured-value lines **d**.

Pay attention that the reference plane of the measurement (e.g. the rear edge of the measuring tool) remains exactly at the same location for all individual measurements within a measuring sequence.

English | 29

c) Indirect length measurement (see figure D)

Select the indirect length measurement .

Pay attention that the measuring tool is positioned at the same height as the sought measuring point. Now, tilt the measuring tool around the reference plane and measure distance “1” as for a length measurement.

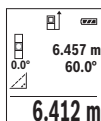

Upon completion of the measurement, the result for the sought distance “X” is displayed in the result line **e**. The measuring values for the distance “1” and the angle “ α ” are displayed in the measured-value lines **d**.

Inclination Measurement/Digital Spirit Level

Select the inclination measurement/digital spirit level .

The measuring tool automatically switches between two states.

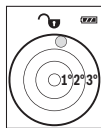

The digital spirit level is used to check the horizontal or vertical alignment of an object (e.g. washing machine, refrigerator, etc.).

When the inclination 3° exceeds, the ball in the display lights red.

30 | English



Inclination measurement is used to measure a slope or incline (e.g. of stairs, railings, when fitting furniture, laying pipes, etc.).

The left-hand side of the measuring tool serves as the reference level for grade measurement. If the display flashes during measurement, the measuring tool has been tipped too heavily to the side.

Memory Functions

The value or end result of each completed measurement is automatically saved.

Memory value display

Maximum 20 values (measured values or end results) can be retrieved.

Press the memory button **6** [].

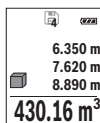

The number of the memory value is shown at the top of the display, the corresponding memory value is shown at the bottom and the corresponding measuring function is shown on the left. Press button **3** [**+**] to browse forwards through the saved values.

Press button **8** [**-**] to browse backwards through the saved values.



English | 31

If there is no value available in the memory, “**0.000**” is shown at the bottom of the display and “**0**” at the top.

The oldest value is located in position 1 in the memory, while the newest value is in position 20 (when 20 memory values are available). When a further value is saved, the oldest value in the memory is always deleted.

Deleting the Memory

Press the memory button **6** [] to delete the contents of the memory. Then briefly press the On/Off button **5** [] to delete the displayed value.

To delete all values in the memory, press the **4** button and the On/Off button **5** at the same time, [] then release the On/Off button **5** [].

Adding/Subtracting Values

Measured values or end results can be added or subtracted.

Adding Values

The following example describes the addition of areas:

Measure an area as described in section “Area Measurement”, see page 25.

32 | English

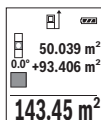

Press the button **3** [+]. The calculated area and the symbol “+” will be displayed.

Press the measuring button **2** [▲] to start another area measurement. Measure the area as described in section “Area Measurement”, see page 25. Once the second measurement is completed, the result of the second area measurement is displayed below. To show the end result, press the measurement button **2** [▲] once more.

Note: With a length measurement, the end result is displayed immediately.

To exit addition, press button **7** [Func].

Subtracting Values

To subtract values, press button **8** [-]. The subsequent steps are the same as for “Adding Values”.

Deleting Measured Values

Briefly pressing the On/Off button **5** [⊖] will delete the last measured value in all measuring functions. Repeated brief pressing of the On/Off button **5** [⊖] will delete the measured values in reverse order.

Changing the Unit of Measure

Unit of measure “m” (metres) is set by default.

Switch the measuring tool on.

Press and hold the **7 [Func]** button to enter the “basic configurations” menu. Select the type of measuring device you use:

- “m/cm” (3 601 K72 H50)
- “ft/m” (3 601 K72 HK0)
- “尺/m” (3 601 K72 HC0)

Press button **3 [+]** or button **8 [-]**, to change the unit of measure.



Press the On/Off button **5** [] to exit the menu item. The selected setting remains saved after you switch off the measuring tool.

Switching the Sound On and Off

The sound is switched on by default.

Switch the measuring tool on.

Press and hold the **7 [Func]** button to enter the “basic configurations” menu. Select . Press the **3 [+]** button or the **8 [-]** button to switch the sound on and off.

To exit the menu item, press the measuring button **2** [] or the On/Off button **5** []. The selected setting remains saved after you switch off the measuring tool.

Working Advice

General Information

The reception lens **14** and the laser beam outlet **15** must not be covered when taking a measurement.

The measuring tool must not be moved while taking a measurement. Therefore, place the measuring tool, as far as this is possible, against or on a firm stop or supporting surface.

Influence Effects on the Measuring Range

The measuring range depends on the lighting conditions and the reflective properties of the target surface. For better visibility of the laser beam in extraneous light, use the laser viewing glasses **18** (accessories) and the laser target plate **17** (accessories) or shade the target area.

Influence Effects on the Measuring Result

Due to physical effects, faulty measurements cannot be excluded when measuring on different surfaces.

Included here are:

- Transparent surfaces (e.g., glass, water),
- Reflecting surfaces (e.g., polished metal, glass),
- Porous surfaces (e.g. insulation materials),
- Structured surfaces (e.g., roughcast, natural stone).

If required, use the laser target plate **17** (accessory) on these surfaces.

Furthermore, faulty measurements are also possible when sighting inclined target surfaces.

Also, air layers with varying temperatures or indirectly received reflections can affect the measured value.

Accuracy Check and Calibration of the Grade Measurement (see figures E1 – E2)

Regularly check the accuracy of the grade measurement. This is done by carrying out a reversal measurement. For this, place the measuring tool on a table and measure the grade. Turn the measuring tool by 180° and measure the grade again. The difference of the indicated reading may not exceed by more than 0.3° (max.).

In the event of larger deviations, you have to recalibrate the measuring tool. For this, select . Follow the instructions on the display.

After severe temperature changes and impact, we recommend an accuracy check and, if required, to recalibrate the measuring tool. After a temperature change, the measuring tool must acclimate for a while before calibrating.

36 | English

Accuracy Check of the Distance Measurement

The accuracy of the measuring tool can be checked as follows:

- Select a permanently unchangeable measuring section with a length of approx. 3 to 10 metres; its length must be precisely known (e.g. the width of a room or a door opening). The measurement should be carried out under favourable conditions, meaning, the measuring distance must be indoors and the target surface for the measurement must be smooth and reflect well.
- Measure the distance 10 times in succession.

The deviation of the individual measurements from the average value must not exceed ± 4 mm over the entire measuring section in favourable conditions. Record the measurements in order to be able to compare the accuracy at a later date.

Working with the Tripod (Accessory)

The use of a tripod is particularly necessary for larger distances. Position the measuring tool with the 1/4" thread **13** onto the quick-change plate of the tripod **19** or a commercially available camera tripod. Tighten the measuring tool with the locking screw of the quick-change plate.

Set the corresponding reference level for measurement with a tripod by pushing button **4** (the reference level is the thread).

Error Message

If a measurement cannot be performed correctly, the error message "Error" appears in the display. Switch the measuring tool off and back on, and start the measurement again.



The measuring tool monitors correct functioning in every measurement. If a defect is detected, the display will indicate only the symbol shown opposite and the measuring tool switches itself off. In this case, have the measuring tool checked by an after-sales service agent for Bosch power tools.

Maintenance and Service

Maintenance and Cleaning

Keep the measuring tool clean at all times.

Do not immerse the measuring tool in water or other fluids.

Wipe off debris using a moist and soft cloth. Do not use any cleaning agents or solvents.

Maintain the reception lens **14** in particular, with the same care as required for eye glasses or the lens of a camera.

38 | English

If you discover a fault or require a repair, send the measuring tool to an authorised Bosch after-sales service agent.

After-sales Service and Application Service

Our after-sales service responds to your questions concerning maintenance and repair of your product as well as spare parts. Exploded views and information on spare parts can also be found under:

www.bosch-pt.com

Bosch's application service team will gladly answer questions concerning our products and their accessories.

In all correspondence and spare parts orders, please always include the 10-digit article number given on the nameplate of the product.

People's Republic of China

China Mainland

Bosch Power Tools (China) Co., Ltd.

567, Bin Kang Road

Bin Jiang District 310052

Hangzhou, P. R. China

Service Hotline: 4008268484

Fax: (0571) 87774502

E-Mail: contact.ptcn@cn.bosch.com

www.bosch-pt.com.cn

English | 39

HK and Macau Special Administrative Regions

Robert Bosch Hong Kong Co. Ltd.
21st Floor, 625 King's Road
North Point, Hong Kong
Customer Service Hotline: +852 2101 0235
Fax: +852 2590 9762
E-Mail: info@hk.bosch.com
www.bosch-pt.com.hk

Indonesia

PT Robert Bosch
Palma Tower 10th Floor
Jl. RA Kartini II-S Kaveling 6 Sek II
Pondok Pinang, Kebayoran Lama
Jakarta Selatan 12310
Indonesia
Tel.: (021) 3005 5800
Fax: (021) 3005 5801
E-Mail: boschpowertools@id.bosch.com
www.bosch-pt.co.id

Philippines

Robert Bosch, Inc.
28th Floor Fort Legend Towers,
3rd Avenue corner 31st Street,
Fort Bonifacio Global City,
1634 Taguig City, Philippines



40 | English



Tel.: (02) 8703871

Fax: (02) 8703870

matheus.contiero@ph.bosch.com

www.bosch-pt.com.ph

Bosch Service Center:

9725-27 Kamagong Street

San Antonio Village

Makati City, Philippines

Tel.: (02) 8999091

Fax: (02) 8976432

E-Mail: rosalie.dagdagan@ph.bosch.com

Malaysia

Robert Bosch Sdn. Bhd.

No. 8A, Jalan 13/6

G.P.O. Box 10818

46200 Petaling Jaya

Selangor, Malaysia

Tel.: (03) 79663194

Fax: (03) 79583838

E-Mail: cheehoe.on@my.bosch.com

Toll-Free: 1800 880188

www.bosch-pt.com.my

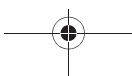
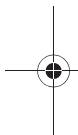

English | 41

Thailand

Robert Bosch Ltd.
Liberty Square Building
No. 287, 11 Floor
Silom Road, Bangrak
Bangkok 10500
Tel.: 02 6393111
Fax: 02 2384783
Robert Bosch Ltd., P. O. Box 2054
Bangkok 10501, Thailand
www.bosch.co.th

Bosch Service – Training Centre
La Salle Tower Ground Floor Unit No.2
10/11 La Salle Moo 16
Srinakharin Road
Bangkaew, Bang Plee
Samutprakarn 10540
Thailand
Tel.: 02 7587555
Fax: 02 7587525



42 | English



Singapore

Powerwell Service Centre Ptd Ltd
65 Ubi Crescent, #06-03 Hola Centre
Singapore 408559
Tel.: 6746 9770/71
Fax: 6746 9760
E-Mail: powerwellsc@gmail.com
Toll-Free: 1800 3338333
www.bosch-pt.com.sg

Vietnam

Robert Bosch Vietnam Co. Ltd
13th Floor, 194 Golden Building
473 Dien Bien Phu Street
Ward 25, Binh Thanh District
84 Ho Chi Minh City
Vietnam
Tel.: (08) 6258 3690
Fax: (08) 6258 3692
Hotline: (08) 6250 8555
E-Mail: tuvankhachhang-pt@vn.bosch.com
www.bosch-pt.com.vn
www.baohanhbosch-pt.com.vn

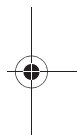
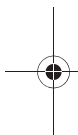

1 609 92A 3F7 | (13.10.16)

Bosch Power Tools



English | 43

Australia, New Zealand and Pacific Islands

Robert Bosch Australia Pty. Ltd.

Power Tools

Locked Bag 66

Clayton South VIC 3169

Customer Contact Center

Inside Australia:

Phone: (01300) 307044

Fax: (01300) 307045

Inside New Zealand:

Phone: (0800) 543353

Fax: (0800) 428570

Outside AU and NZ:

Phone: +61 3 95415555

www.bosch-pt.com.au

www.bosch-pt.co.nz

Egypt

Unimar

20 Markaz kadmat

El tagmoa EL Aoul – New Cairo

Tel: +2 02 224 76091 - 95 / + 2 02 224 78072 - 73

Fax: +2 02 224 78075

E-Mail: adelzaki@unimaregypt.com



44 | English



Ethiopia

Forever plc
Kebele 2,754, BP 4806,
Addis Ababa , Ethiopia
Tel: +251 111 560 600, +251 111 560 600
E-Mail: foreverplc@ethionet.et

Nigeria

C. Woermann Ltd.
P.O. Box 318
6, Badejo Kalesanwo Street
Matori Industrial Estate
Lagos, Nigeria
Tel: +234 17 736 498, +234 17 730 904
E-Mail: d.kornemann@woermann-nigeria.com

Republic of South Africa

Customer service

Hotline: (011) 6519600

Gauteng – BSC Service Centre

35 Roper Street, New Centre
Johannesburg
Tel.: (011) 4939375
Fax: (011) 4930126
E-Mail: bsctools@icon.co.za



KZN – BSC Service Centre

Unit E, Almar Centre
143 Crompton Street
Pinetown
Tel.: (031) 7012120
Fax: (031) 7012446
E-Mail: bsc.dur@za.bosch.com

Western Cape – BSC Service Centre

Democracy Way, Prosperity Park
Milnerton
Tel.: (021) 5512577
Fax: (021) 5513223
E-Mail: bsc@zsd.co.za

Bosch Headquarters

Midrand, Gauteng
Tel.: (011) 6519600
Fax: (011) 6519880
E-Mail: rbsa-hq.pts@za.bosch.com

Disposal

Measuring tools, accessories and packaging should be sorted for environmental-friendly recycling.

Do not dispose of measuring tools and batteries/rechargeable batteries into household waste!

Subject to change without notice.